

# Hall effect Current Sensor

## SCK3 Series

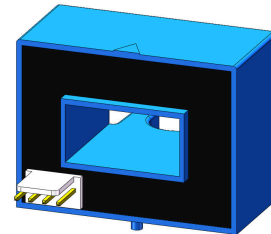

### Product description

---

#### Features:

- Based on the Hall effect measurement principle, open loop circuit method.
- The isolation voltage between primary and secondary is greater than 3000VAC.
- Easy to install, small in size and not occupying space.
- The material of the product has good mechanical properties such as corrosion resistance, aging resistance, and heat resistance.
- Potting glue has elastic characteristics.
- Designed according to UL94-V0 flame retardant rating.

#### Performance:

- It can measure DC, AC, pulse, and various irregular waveform currents of cable conductors under isolation conditions.
- High measurement accuracy, wide range, fast response speed, low zero drift, low temperature drift, small overshoot, and good linearity.
- The dynamic performance (DI/DT and response time) is the best when the busbar is completely filled with the primary perforation.
- Strong ability to resist external electromagnetic interference (ESD, EFT, CS, CE, BCI, dv/dt, etc.).

#### Implementation standards:

- GB 7665
- JB/T 7490
- JB/T 9329-1999
- JB/T9473-1999
- SJ/20792-2000

#### Application:

- It can be applied to AC frequency conversion speed regulation and servo motor traction.
- Battery power, uninterruptible power supply.
- Switching power supply, welding machine power supply.
- Electric vehicles.
- New energy sources such as photovoltaics.

#### Certifications



## Technical Parameters

Model Parameters (25°C)	SCK3-						
	50A	100A	150A	200A	300A	500A	600A
Primary Current (A) $I_{PN}$	50A	100A	150A	200A	300A	500A	600A
Primary Current Max. Peak Value (A) $I_{PM}$	±150A	±300A	±450A	±600A	±900A	±1200A	±1200A
Output voltage (V) $V_{out}$ @± $I_{PN}$ , $R_L=10K\Omega$	±4V±1%						

## Electrical Data

Item	Min.	Max.	Typical	Unit
Input power supply voltage range $V_c$ (Remark 1)	±11	±15	±18	$V_{DC}$
Operating voltage fluctuation range $V_{cc}$ (Remark 2)	±14.25	±15	±15.75	$V_{DC}$
Current consumption $I_c$	-	±13	±15	mA
Withstand resistance $R_{INS}@500V DC$	1000	-	-	$M\Omega$
Output voltage $V_{out}$ @ $I_{PN}$ , $R_L=10K\Omega$ , $T_A=25^\circ C$	3.96	4.0	4.04	V
Output internal resistance $R_{OUT}$	101	102	103	$\Omega$
Load Resistance $R_L$ (Remark 3)	1	10	-	$K\Omega$
Accuracy X @ $I_{PN}$ , $T_A=25^\circ C$	-	±1	±1.5	%
Linearity $\epsilon_L$ @ $R_L=10K\Omega$ , $T_A=25^\circ C$	-	±0.5	±1.0	% $I_{PN}$
Offset voltage $V_{OE}@T_A=25^\circ C$	-	±10	±20	mV
Hysteresis voltage $V_{OM}$ @ $I_{PN}\rightarrow 0$	-	±10	±20	mV
Temperature Coefficient of Offset Voltage $TCV_{OE}$	-	±0.5	±1	mV/ $^\circ C$
Output voltage temperature coefficient $TCV_{out}$	-	±0.05	±0.1	%/ $^\circ C$
Response time $t_D$ @ $0\rightarrow I_{PN}$	-	3	5	us
Bandwidth BW	-	50	-	Hz
Ambient operating temperature $T_A$	-40	25	85	$^\circ C$
Ambient storage temperature $T_s$	-40	25	85	$^\circ C$
Withstand voltage $V_D@50Hz, 60s, 0.1mA$		3000		$V_{AC}$
Weight m		55		g

Remarks:

1. If VC is less than the minimum value, the measurement will be inaccurate. If VC is greater than the maximum value, it may cause permanent failure of the measuring device.
2. When  $\pm 12V < V_{CC} < \pm 15V$ , will reduce the measurement range.
3. 
$$V_{OUT} = 4.00 * \frac{R_L}{102 + R_L} * \frac{I_P}{I_{PN}} + V_{OE}$$
4.  $di/dt > 50A/uS$

## Dimension (in mm) & Wiring ref.:

### SCK3 Dimension

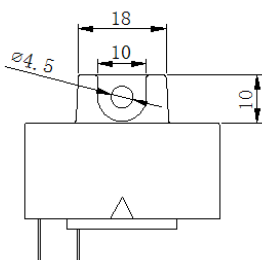
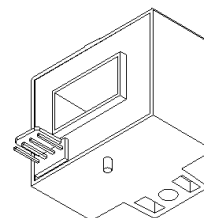
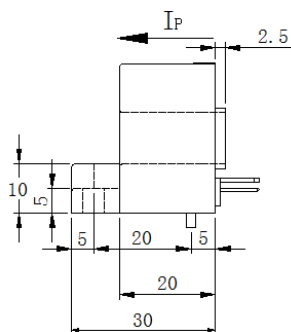
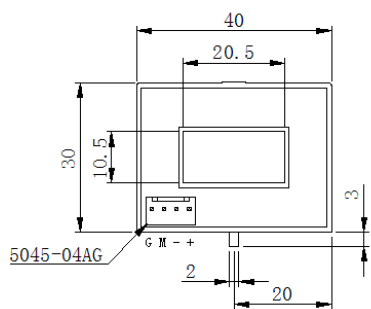

序号	标识	说明
1	+	+15V
2	-	-15V
3	M	Output
4	G	0V

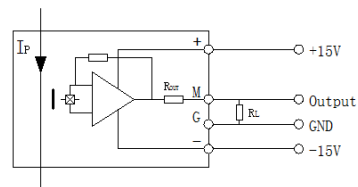

## SCK3A Dimension

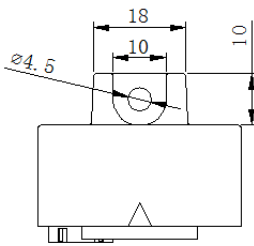
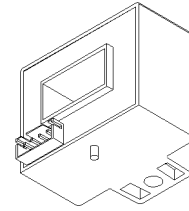
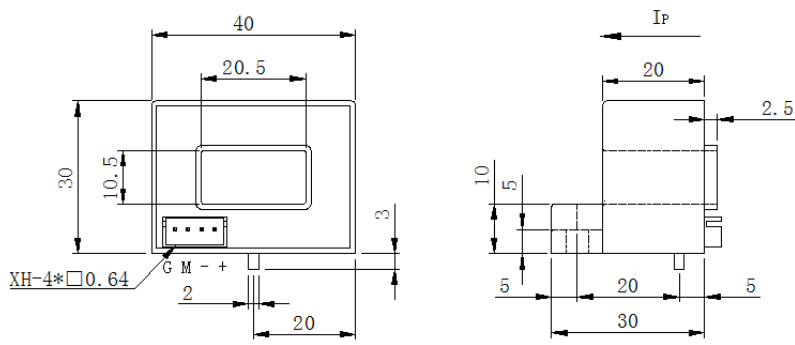

序号	标识	说明
1	+	+15V
2	-	-15V
3	M	Output
4	G	0V

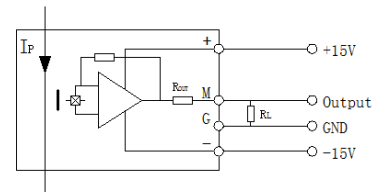

## SCK3P

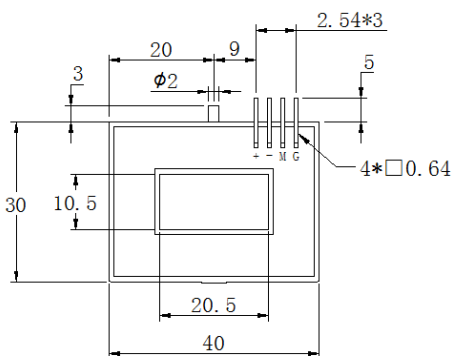
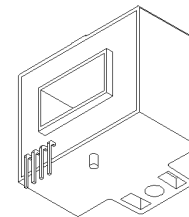
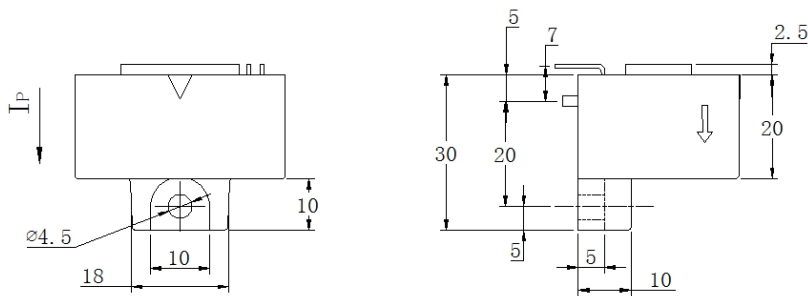

序号	标识	说明
1	+	+15V
2	-	-15V
3	M	Output
4	G	0V

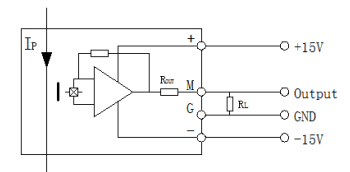

## SCK3T

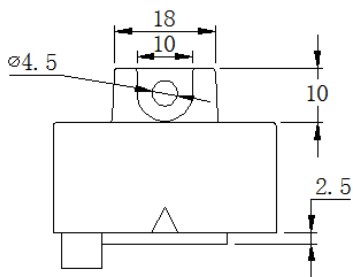
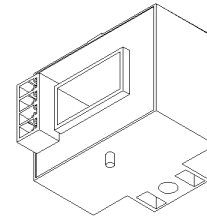
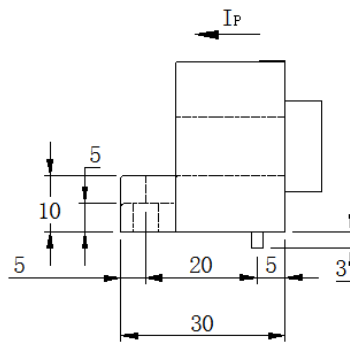
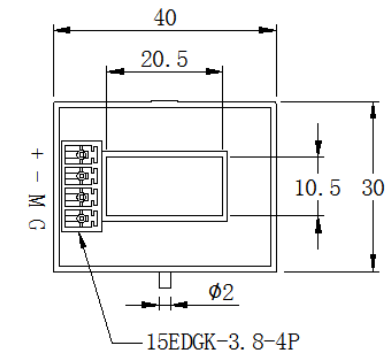

序号	标识	说明
1	+	+15V
2	-	-15V
3	M	Output
4	G	0V

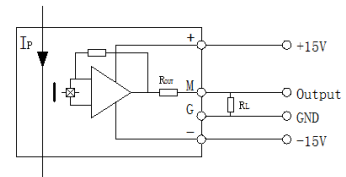

## SCK3D

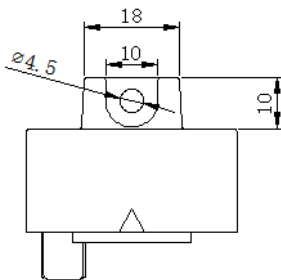
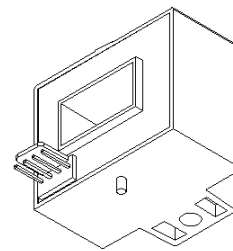
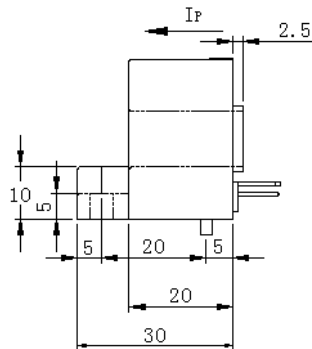
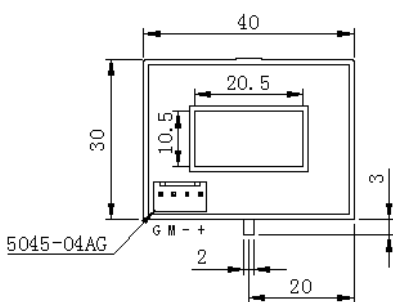

序号	标识	说明
1	+	+5V
2	-	NC
3	M	Output
4	G	0V

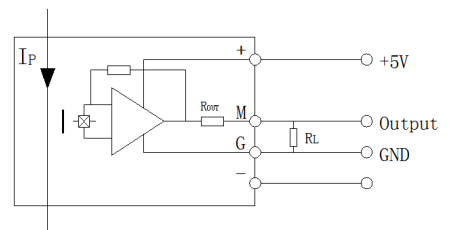

# SCK3R

Connector Molex 5045-04A

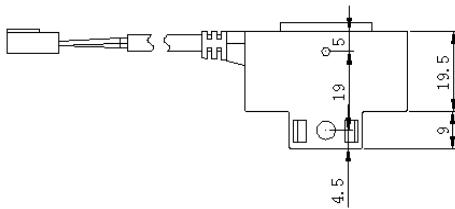
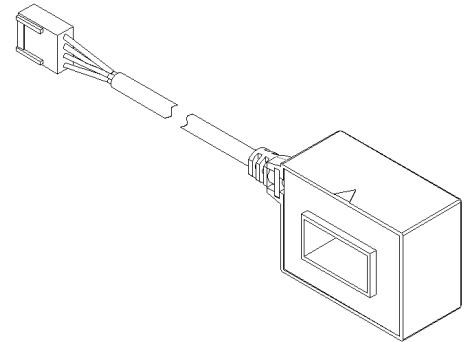
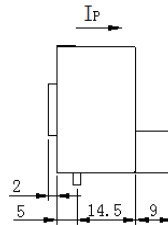
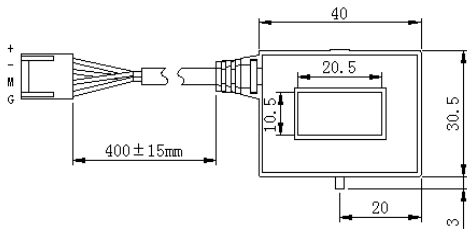
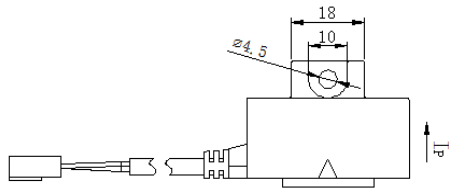

序号	标识	颜色	说明
1	+	红色	+15V
2	-	黄色	-15V
3	M	绿色	OUT
4	G	黑色	GND

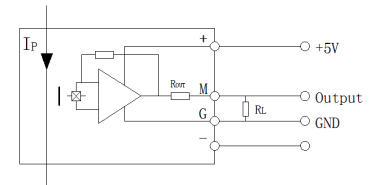

# SCK3R

Connector: JST B4B-XH-A

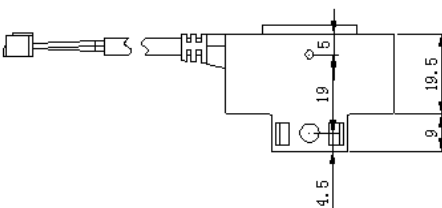
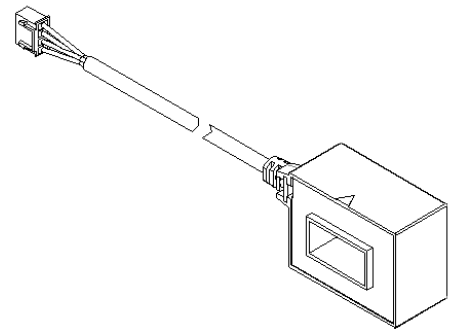
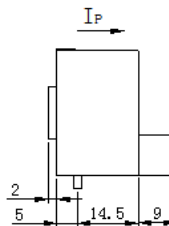
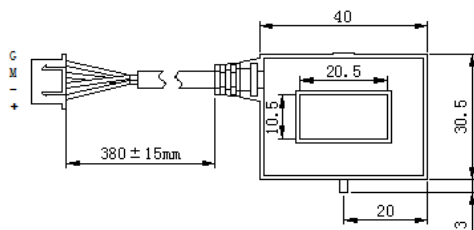
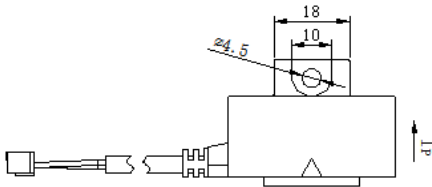

序号	标识	颜色	说明
1	+	红色	+15V
2	-	黄色	-15V
3	M	绿色	OUT
4	G	黑色	GND

Notes:

1. Size error:  $\pm 1\text{mm}$ ;
2. Primary aperture:  $\square 20.5*10.5\text{mm}$ ;
3. Fastening hole:  $\phi 4.5\text{mm}$ ;
4. The IP indication direction is the positive direction of the current;
5. The temperature of the primary conductor shall not exceed  $105^{\circ}\text{C}$ ;
6. Incorrect wiring may cause damage to the sensor.